



## MANUAL



CONTROL UNIT FOR ROTARY HEAT EXCHANGER

# VariMax50

CE

Article no. F21050501

**IBC**control



## TABLE OF CONTENTS

Installation instructions	2
Mounting	2
Safety instructions	3
Manufacturer's declaration	
Declaration of conformity	4
Description of functions	5
Technical data, control unit	6
Technical data, motor	6
Functions	6
- DIP switch	7
- Operational indications	7
- Alarms	7
- Settings via potentiometer	8
- Reset	8
Connection diagram	9
Connections	9
Input signal/Rotation speed	10
Checks before powering up the control unit	10
Commissioning the equipment	10
EMC installation	11
EMC gland	11
Own notes	12-13

## INSTALLATION INSTRUCTIONS

Warning indication



The control unit must only be used in perfect technical condition. Any damage that may affect safety must be dealt with immediately.

Maintenance/Repairs

The function of the control unit should be checked regularly. Troubleshooting and repairs must only be performed by trained personnel. Prescribed electrical protection must be implemented.

Disposal and recycling

When replacing components or when the control unit in its entirety needs replacing, please follow the advice below: The aim shall always be to achieve the maximum possible recycling of raw materials, with the minimum possible environmental impact. Never dispose of electrical components with ordinary waste; always use the designated collection points. Disposal should be effected as environment-friendly as the technology allows in terms of environmental protection and recycling.

## MOUNTING



## SAFETY INSTRUCTIONS

The following symbols and references will be used in this description. These instructions are important; they apply to personal and technical safety during operation.



This safety instruction refers to instructions whose specific intent is to avoid the risk of personal injury and to prevent damage to equipment.



Lethal Danger! Electrical components are powered by electrical current!

NB! Switch off main power before removing the cover.

Never touch electrical components or contacts while main current is switched on. Risk of electrocution, resulting in serious injury or death.

Connected terminals contain residual voltage even after the main current has been switched off.

## MANUFACTURER'S DECLARATION DECLARATION OF CONFORMITY

<b>Manufacturer</b>	IBC control AB Brännerigatan 5 A SE-263 37 Höganäs Sweden Tel: +46 42 33 00 10
<b>Product</b>	Control unit for rotary heat exchanger
<b>Type designation</b>	VariMax50 CE
<b>Applicable EU Directives</b>	EMC Directive 2014/30/EU Low Voltage Directive 2014/35/EU RoHS Directive 2011/65/EU including Delegated Directive EU2015/863
<b>Applicable UK Directives</b>	The Electromagnetic Compatibility Regulations 2016 The Electrical Equipment (Safety) Regulations 2016 The Restriction of the Use of Certain Hazardous Substances in Electrical and Electronic Equipment Regulations 2012
<b>Harmonizing standards for EU/UK Directives</b>	BS EN 61800-3:2004 - Emission kategori C1, Immunitet kategori C2 BS EN 61800-5-1/2 - The control unit is intended for installation in environments with a pollution rating of 2 (Pollution degree 2)

This declaration of conformity is issued under the full responsibility of the manufacturer

Höganäs 2023-05-01  
IBC control AB



Christer Persson  
MD



---

The FreeRTOS v6.1.0 (<http://www.freertos.org>) software is used in this product and this source code can be supplied by us.

## DESCRIPTION OF FUNCTIONS

- The VariMax50 CE is part of a range of control units adapted for optimum control of rotary heat exchangers, with the necessary additional functions. The range consists of three sizes: VariMax25 CE, VariMax50 CE and VariMax100 CE.  
All control units run a 3-phase stepping motor.  
All control units have an input signal of 0-10 V.
- The VariMax50 CE is designed for rotors up to 2500 mm with a rotor speed of max. 12 rpm. If the rotor requires a faster rotor speed, the rotor diameter should be reduced.
- The VariMax50 CE has built-in input signal shift, which means that the rotor's efficiency is proportional to the input signal.
- The VariMax50 CE has a preset threshold value of 0,1 V (hysteresis 0,13–0,07 V).  
If the input signal falls below this value, the rotor will stop.
- The VariMax50 CE has a rotation monitor (magnet mounted on the rotor with associated magnet sensor) and a built-in cleaning function.  
The functions can be disconnected via DIP switches.
- The VariMax50 CE starts automatically after voltage drop-out, and resets all alarms on restart. 
- The VariMax-motor50 CE is a stepper motor with substantial moment over the entire speed range.
- When the motor is stationary, a holding torque is activated, which means that the rotor always remains still.  
The holding torque disappears if the voltage to the control unit is lost.
- The motor is mounted with a 3 m cable as standard.

## TECHNICAL DATA, CONTROL UNIT

Connection voltage	1x230-240 V +/-15 % 50/60 Hz
Power input, max.	240 W
Input current, max.	1,9 A
External fuse, max.	10 A
Output voltage*)	3x0-280 V
Motor current/phase	2 A
Internal fuse **)	2,5 AT

Output frequency	0-312 Hz
Acceleration and retardation time	30 sec
Ambient temperature, non condensing	-30 - +45 °C -40 - +45 °C (***)
Protection form	Type 1
Weight	1,2 kg
Dimensions, HxWxD	203x187x70 mm

\*) Exact value cannot be obtained with a digital measuring instrument

\*\*) The fuse protects both motor and electronics

\*\*\*) Note, The control unit must be connected to power all the time

## TECHNICAL DATA, MOTOR

Max. moment	4 Nm
Min. rotation speed	1 rpm
Max. speed (rpm)	375 rpm
Motor temperature mantle max	110 °C
Shaft diameter	14 mm
Shaft length	40 mm

Ambient temperature	-30 - +45 °C -40 - +45 °C (***)
Protection form	IP54
Weight incl. motor bracket	4 kg
Dimensions incl. shaft and motor bracket HxWxD	130x130x171 mm

\*\*\*) Note, The control unit must be connected to power all the time

## FUNCTIONS

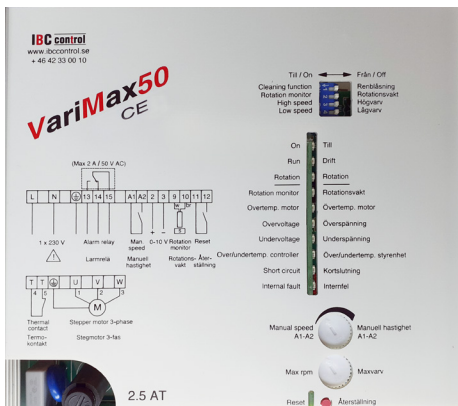

← DIP switch  
ON to left

← Operational indications

← Alarm indications

← Settings

← Reset button



## DIP SWITCH

<b>Cleaning function</b>	Cleaning function connected in ON position. When the rotor has stopped for 10 minutes, the cleaning function is activated and the rotor starts to rotate. As a warning, the rotor first rotates for 6 seconds at a motor speed of 5 rpm, the rotor is then stationary for 3 seconds. After this, the actual cleaning starts, for a random time, between 10 to 20 seconds with the motor at 20 rpm.
<b>Rotation monitor</b>	Rotation monitor connected in ON position.
<b>High speed *)</b>	The rotor rotates at the set max. rpm when the switch is set to ON. After a test run, make sure the DIP switch is set to OFF.
<b>Low speed *)</b>	The rotor rotates at the preset min. speed (1 rpm) when the switch is set to ON. After a test run, make sure the DIP switch is set to OFF.

\*) Manual operation (test mode)

## OPERATIONAL INDICATIONS

<b>On/alarm</b>	"Voltage on" comes on with a fixed light. Flashes when the control unit has tripped.
<b>Run</b>	Comes on when the motor is to rotate, i.e. when the input signal exceeds the threshold value.
<b>Rotation</b>	Flashes when the magnet passes the magnetic sensor, regardless of the "Rotation monitor" DIP switch setting. Flashes even if the input signal is lower than the threshold value.

## ALARMS

In the event of an alarm the control unit restarts after 30 seconds. The respective red light diode comes on for the same duration (30 seconds).

After restart the light diode goes out, this happens twice. The third time, the alarm relay closes and the alarm "moves on". In order for the alarm relay to close and the alarm to "move on", the above three alarm signals must occur within 90 minutes, otherwise the sequence is reset.

A steady green LED is activated for the first and second alarm and begins to flash on the third alarm. All alarms subsequently remain active.

<b>Rotation monitor</b>	Generates an alarm and trips if a pulse has not been received every 30 minutes at minimum speed (1 rpm) and every 20 seconds at maximum speed (375 rpm). The time between these speeds is linear. The function can be disconnected via DIP switches.
-------------------------	--

Continued on next page

Continued from previous page

Probable fault cause during installation	<ul style="list-style-type: none"><li>- Magnet turned the wrong way</li><li>- Rotation monitor incorrectly connected (wrong polarity), refer to "connections" on page 9</li><li>- Gap too wide between the magnetic sensor and magnet; max 15 mm</li></ul>
Probable fault cause in operation	<ul style="list-style-type: none"><li>- Broken belt</li><li>- Belt slipping</li><li>- Stuck rotor</li><li>- Magnetic sensor or magnet not intact</li></ul>
<b>Motor temperature</b>	Alarms and trips if motor winding temperature is too high. The temperature switch in the motor reverts to normal mode when the temperature drops.
<b>Overvoltage</b>	Alarms and trips if the input voltage exceeds 265 V.
<b>Undervoltage</b>	Alarms and trips if the input voltage falls below 190 V.
<b>Over /under-temperature</b>	Alarms and trips if the temperature in the control unit goes above/below safe temperature level (+85 - -30 °C).
<b>Short circuit</b>	Alarms and trips in the event of short circuit phase-phase or phase-earth.
Probable cause	<ul style="list-style-type: none"><li>- Short circuit between phases in cable or motor</li><li>- Short circuit between phase-earth in cable or motor</li><li>- Interruption to one phase in cable or motor</li><li>- No motor or wrong motor connected</li></ul> <p>Measure motor resistance; it should be identical on all coils.</p>
<b>Internal fault</b>	Alarms and trips if an internal fault in the control system has occurred.

## SETTINGS VIA POTENTIOMETER

<b>Manual speed</b>	By closing A1-A2 the speed is controlled via the potentiometer marked "Manual speed". Can be regulated between 1 and 375 rpm. The rotor rotates at the set speed, whatever the value of the input signal. Factory setting: 1 rpm on motor shaft.
<b>Max rpm</b>	Potentiometer for adjusting max. speed. Regulates between 50 and 375 rpm. Factory setting: 50 rpm on motor shaft.

## RESET

<b>Reset</b>	Reset button for resetting the control unit. The control unit is also reset in the event of voltage drop-out and closure between terminals 11 and 12.
--------------	---

## CONNECTION DIAGRAM

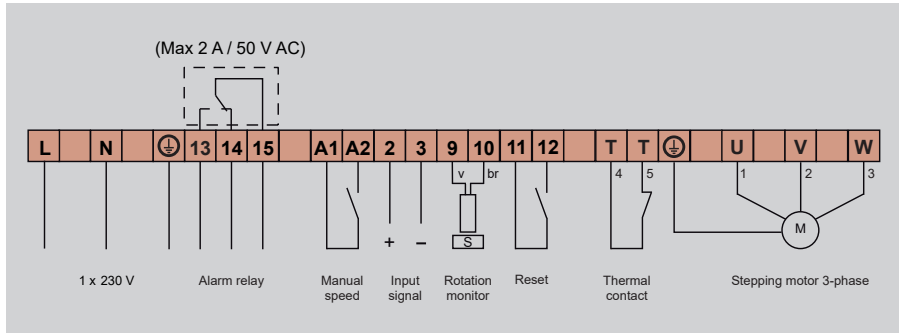

## CONNECTIONS



The voltage must be switched off before undertaking any work on the equipment.  
Recommended torque 0,5 Nm, max. torque 0,8 Nm.

<b>Connection voltage (L-N-PE)</b>	1x230-240 V +/-15 %, 50/60 Hz. NOTE! Protective earth must always be connected.
<b>Alarm relay (13-14-15)</b>	Closes between 14-15 in the event of an alarm or voltage drop-out. Max 2 A resistive load / 50 V AC.
<b>Manual speed (A1-A2)</b>	Produces set rotation speed on connection.
<b>Input signal (2-3)</b>	0-10 V. Plus connected to terminal 2, minus to terminal 3.
<b>Rotation monitor (9-10)</b>	White cable connected to terminal 9, brown to terminal 10. The magnet is installed with south side (S) towards the sensor. Max. gap 15 mm.
<b>12 V output (3-11)</b>	Output for 12 V DC. Terminal connection 3 is minus (-), terminal connection 11 is plus (+). Max 50 mA.
<b>Reset (11-12)</b>	Remote reset in the event of alarm. The control unit is reset automatically in the event of voltage drop-out.
<b>Thermal contact (T-T)</b>	 This must be connected to protect the motor against overheating.
<b>Motor (U-V-W)</b>	VariMax-motor50 CE must be used. Direction of rotation is changed by switching two of the phases.

## INPUT SIGNAL/ROTATION SPEED

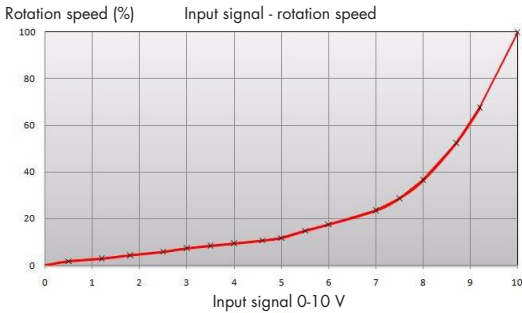

The input signal is directly proportional to the efficacy of the rotor, which implies that input signal and rotation speed are as per the adjacent diagram.

## CHECKS BEFORE POWERING UP THE CONTROL UNIT



- |                   |  |
|-------------------|--|
| <b>Check that</b> | the control unit is connected as per instructions on page 9.<br>Connection voltage 1x230-240 V +/-15%, 50/60 Hz. |
| <b>Check that</b> | the input signal is 0-10 V.  |
| <b>Check that</b> | the rotation monitor and cleaning function are connected.  |

## COMMISSIONING THE EQUIPMENT



Should be accomplished in sequence

- |                                       |   |
|---------------------------------------|---|
| <b>Check that</b>                     | the motor rotates in the right direction in relation to the rotor's direction of rotation. In the event of a fault, switch two phases to the motor.   |
| <b>Adjustment of max speed</b>        | Set the High Speed DIP switch to the ON position.<br>Adjust "Max rpm" so that the rotor rotates at 10-12 rpm (or as per rotor manufacturer's directions).<br>After a test run, set the DIP switch to OFF.             |
| <b>Checking min speed</b>             | Set the Low Speed DIP switch to ON.<br>Check that the rotor starts.<br>The minimum speed is preset.<br>After a test run, set the DIP switch to OFF.   |
| <b>Checking the cleaning function</b> | Switch off the voltage.<br>Make sure the "Cleaning function" DIP switch is set to ON and the input signal is disconnected.<br>After switching on the voltage the rotor rotates for 20 seconds at 12 rpm on the motor. |
| <b>Checking the rotation monitor</b>  | The yellow Rotation LED will flash when the magnet passes the magnetic sensor, regardless of DIP switch position.   |
| <b>Finish by</b>                      | having the control unit drive the rotor at maximum and minimum rotation speeds and checking that the operating rotor speed is correct.  |

## EMC INSTALLATION

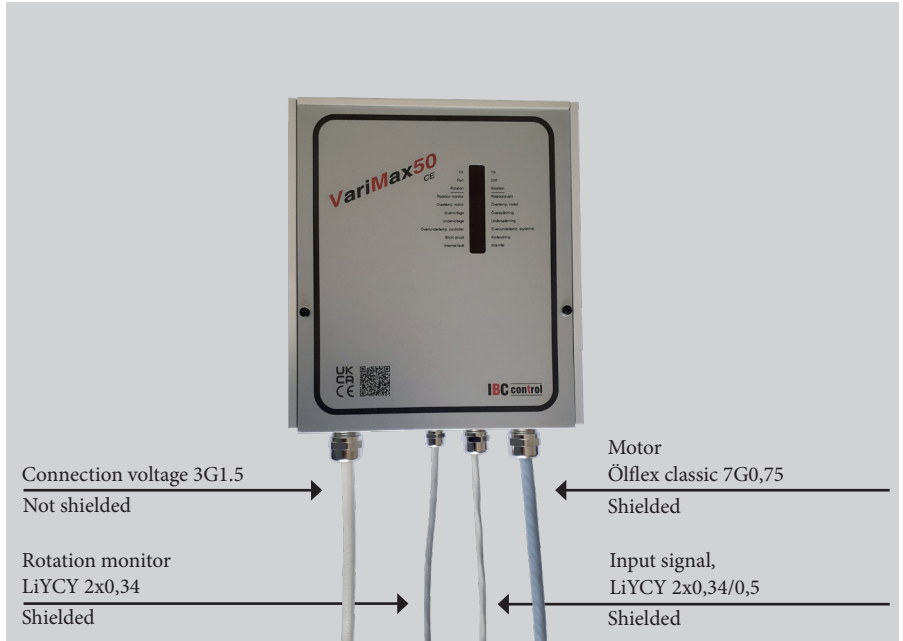

EMC glands must be used for shielded cables.

The above cables or equivalent must be used to comply with the EMC Directive.

## EMC GLAND

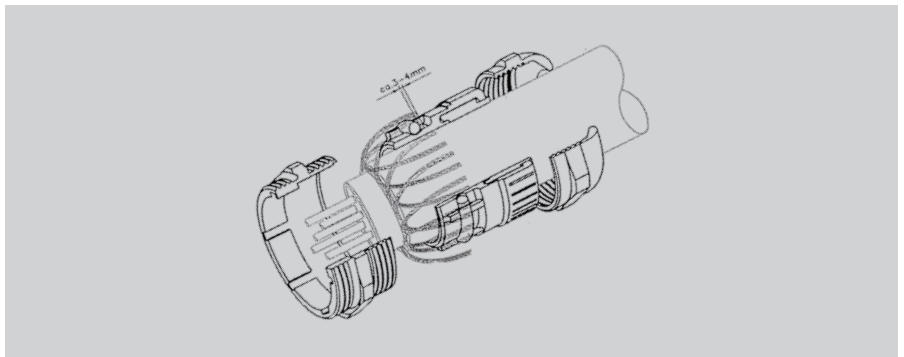

NOTE!

When connecting the shielding to the EMC gland, it is important to connect as shown above.

## OWN NOTES



**OWN NOTES**

A large rectangular area filled with horizontal stripes of varying shades of grey, intended for writing notes. The stripes alternate between a medium grey and a light grey, creating a grid-like pattern for text entry.

F21050907GB  
VERSION 1.0  
2023-05-20

**IBC** control

IBC control AB  
Brännerigatan 5 A  
SE-263 37 Höganäs  
Sweden  
Tel. +46 42 33 00 10  
[www.ibcccontrol.se](http://www.ibcccontrol.se)  
[info@ibcccontrol.se](mailto:info@ibcccontrol.se)